

BEDLOCKER®

ELECTRIC RETRACTABLE TRUCK BED COVER

TOYOTA TACOMA SB & TACOMA DOUBLE CAB XSB INSTALLATION INSTRUCTIONS



#1 RETRACTABLE TRUCK BED COVER

(800) 338-3697

www.paceedwards.com

Pace Edwards Company
2400 Commercial Blvd.
Centralia WA 98531

TABLE OF CONTENTS

Tools Required for Assembly.....	2
Before You Start	2
Drain Hole Locations	2
STEP 1: Remove Contents from Box	2
Packaging Contents	3
STEP 2: Install Wiring Harness	3
STEP 3: Place Canister Install Foam	3
STEP 4: Install Rails.....	4
STEP 5: Installing Clamps.....	4
STEP 6: Lubricating the rails.....	5
STEP 7: Connecting the electronics.....	5
STEP 7: Installing Drain Tubes.....	5
STEP 8: Install Top Cover	5
Release Handle Instructions	6
Helpful Maintenance Hints	6
Warranty Statement.....	7

(BLSP4)

Part #: BL_TOY_TAC_SB_XSB_0711
Canister Part # 2035 & 2074

TOOLS REQUIRED FOR ASSEMBLY:

7/16" wrench or socket #2 Phillips screwdriver
Side Cut Pliers Tape measure

Note: There should be no drilling into the truck body needed on most standard or full-size trucks .

BEFORE YOU START:

Read the instructions carefully before you start. These instructions are written for one-person installation. We have noted where briefly having an extra person's assistance can make installation easier. If you have questions regarding the installation please call our Technical Support Line at (800) 338-3697.

DRAIN HOLE LOCATIONS:

The Bedlocker is designed to carry rainwater from the cover into the canister and then out through the drains. Most truck models have standard OE drain holes or plastic/rubber access ports in the front of the truck bed. Check to make sure your truck has the OE drain holes so that drilling into the sheet metal is not required. If drilling is necessary, be sure to check the underside of the truck bed for the best location. The holes should be located near the side and as far forward as possible. Use a drill bit suitable for sheet metal (such as a taper drill or step drill). Drill drain tube clearance holes at 3/4" (19mm). This will need to be done before installing the cover.

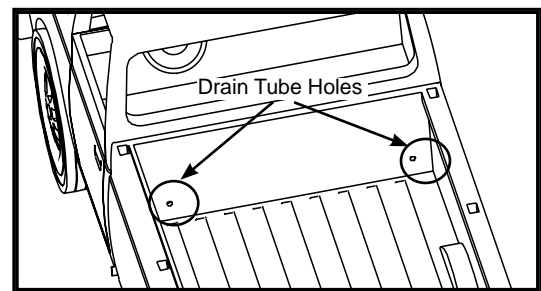

OPTIONAL WIRING HARNESS FOR DASHBOARD SWITCH:

The BedLocker also offers an optional wire harness (**part # BL1120**) to manually operate the tonneau cover from inside the cab of your truck.

This harness is designed to plug into the custom-built electronics control box mounted inside the canister.

Thread the plug through the side of the canister and connect it to the grey/violet plug. Make sure to secure the loose wires inside the canister away from the gear and blanket.

Then run the wire to the cab and attach under the dash in a suitable location.

STEP 1: REMOVE CONTENTS & PLYWOOD PACKAGING

Remove the canister and top cover from the box.

Remove components from inside the canister. Perform a quick inventory to insure all parts are there.

Using the 3/8" wrench or socket remove the 2 bolts holding the plywood packaging supports on the ends of the canister. Discard plywood packaging supports and bolts.

DISCARD PLYWOOD PACKAGING AND BOLTS!

PACKAGING CONTENTS:

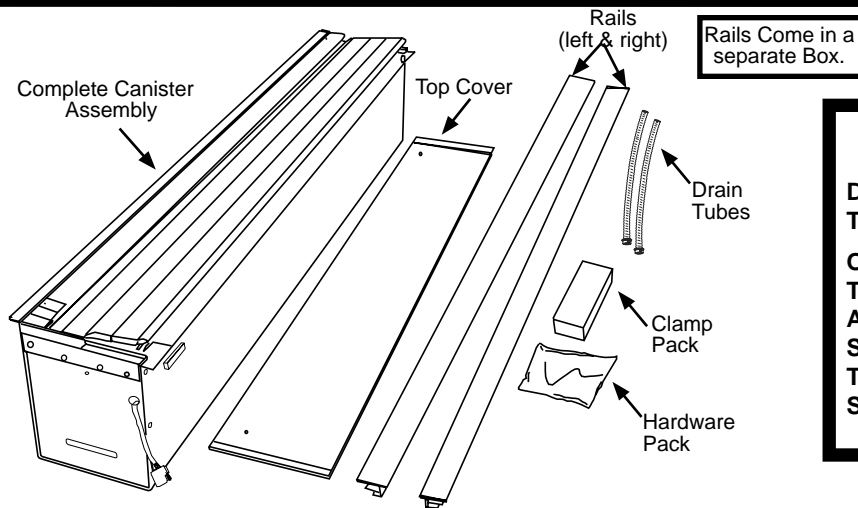

DO NOT USE A KNIFE TO OPEN THE RAIL BOX.

OPEN THE RAIL BOX ALONG THE LENGTH OF THE BOX AND LIFT RAILS OUT TO AVOID SCRATCHING THE SURFACE OF THE RAILS ON THE PACKAGE STAPLES.

STEP 2: INSTALL WIRING HARNESS

HARDWARE USED:

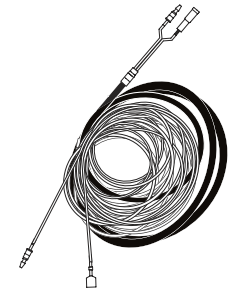

WIRE HARNESS x 1

ZIP TIES x 5

(If the optional wire harness **Part# BL1120** is used, you may want to tape it to the main harness to ease having to pull them through the stake pocket separately).

From inside the truck bed push the long wire harness end **without** the plug through the stake pocket on the drivers side of the truck and out the underside of the truck bed box.

Leave approximately one foot of slack inside the box for mounting the electronics.

Route the wire harness under the truck and to the battery in the engine compartment.

Attach the fuse holder to the end of the Red/positive wire.

(Do not attach to the battery yet.)

Secure the harness with wire ties provided after slack from the canister has been taken out.

STEP 3: PLACE CANISTER IN TRUCK BED

You will need one or two support pieces (We suggest using the top of the box the Bedlocker was shipped in) to set in the truck bed.

Set the support piece approximately one foot from the cab.

Set the Canister on the support(s) in the truck bed. The canister should be resting on the support piece, centered in the truck bed, raising the top of the canister above the bed rails by 2-3 inches.

Hold onto the ribbed blanket and cut the zip tie.

(Do not let the blanket roll back on itself or the underside on the first three ribs can damage the visual surface of the other rolled ribs).

Remove all of the vinyl sheeting protecting the blanket.

Pull the blanket out about 1 foot from the canister and let it hang.

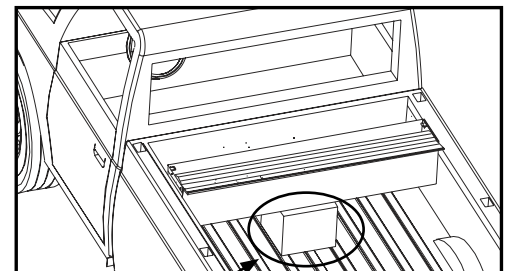

Support Piece

STEP 4: INSTALLING RAILS

The machined end of the rail attaches to the canister.

You will need to lift the hanging portion of the ribbed blanket and thread it in the rail while sliding the rail into the rail grip mounted to the ends of the canister (**the underside of the blanket ribs need to nest on the gear**).

Make sure both flanges of rail slide into the rail grip.

Push the rails forward against the canister.

Complete for both left and right rails.

Remove the support or stand and lower the canister and rail assembly onto the front sill and rails of the truck bed.

Slide the entire canister and rail assembly forward against the cab end of the truck bed.

Close the tailgate and pull the rails only toward it leaving approximately 1/8" gap between the end of the rails and the tailgate.

Be sure to hold the canister in place to ensure it does not move from the front truck bed sill with the rails while adjusting the gap of the rails to the tailgate.

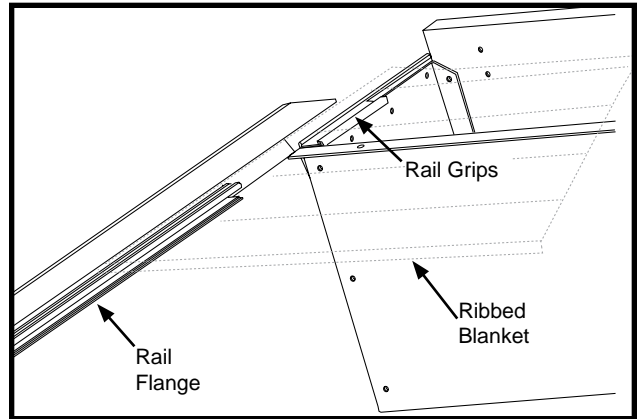

STEP 5: INSTALLING CLAMPS & RAIL BRACKETS

HARDWARE USED:

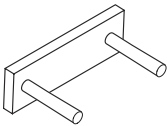

INNER RAIL CLAMP x 4

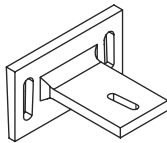

OUTER ANGLED RAIL CLAMP x 4 (NARROW EDGE GOES DOWN!)

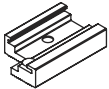

RAIL CLAMP BRACKET A x 2

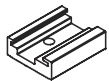

RAIL CLAMP BRACKET B x 2



1/4" FLAT WASHER x 12



1/4" LOCK WASHER x 12



1/4-20 x 5/8" BOLT x 8



RAIL CLAMP NUT x 8

Slide the four (4) Inner Rail Clamps (2 on each side) through the Tie Down Bars of the truck.

Place the Outer Angled Rail Clamps on the Inner Rail Clamps (**MAKE SURE THE NARROWER EDGE IS DOWN ON THE OUTER ANGLED RAIL CLAMPS**) loosely fasten the clamps in place with the 1/4" Washer, 1/4" Lock Washer and Rail Clamp Nut on both sides of the truck bed.

The first clamp should be placed about 6 inches from the canister (closest to truck cab).

The second clamp assembly should be about 4 inches from the end of the Tie Down Bar (closest to the tailgate).

Slide Rail Clamp Bracket A on each Rail followed by Rail Clamp Bracket B.

Rail Clamp Bracket A should be closest to the Cab of the truck.

Loosely assemble the Rail Clamp Brackets to the Outer Angled Rail Clamps with the 1/4" Washer, 1/4" Lock Washer and 1/4-20 x 1/2" Bolt on each side of the truck bed.

Center the Rails in the Truck bed.

Check that the spacing in the truck bed between the Left and Right Rails is 50-5/16".

Once correct spacing is achieved tighten ONLY the Rail Clamp Brackets A & B in place.

With the Tailgate in the closed position correct spacing to the tailgate should be 1/16" to prevent the tailgate from striking the side rails when closing.

Tighten the Set Screws on both Rail Clamp Bracket A to hold rails in position. (Adjust spacing from the tailgate by moving rails forward or backward as needed prior to final tightening of set screws.)

Apply downward pressure while tightening the Outer Angled Rail Clamp to the Inner Rail Clamp, especially on the tailgate end. This will ensure a tight seal, firm seat, and good fit on the truck bed.

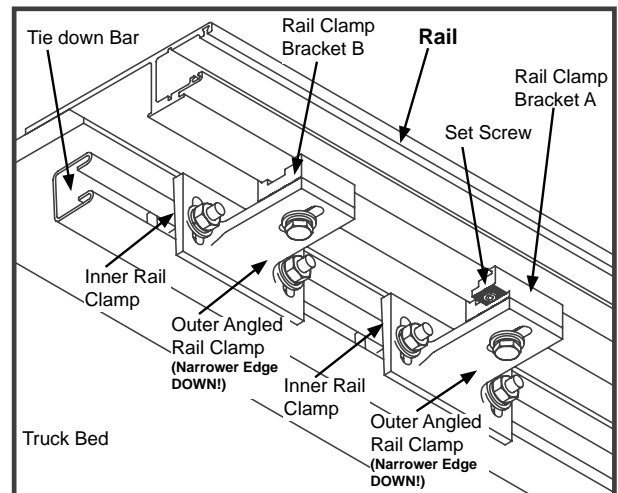

STEP 6: LUBRICATING & PLACING THE SWEEP SEALS

Locate the sweep seals (rubber weather strips) on the rails. Open the provided 303 brand protectant sponge pack (find it adhered to the underside of the top cover) and wipe the underside of the sweep seal and the top of the wear strip.

Extend the cover to the tailgate. Use an Allen wrench if needed to carefully draw out the sweep seal (seal should be angled outwards toward the cover – not rolled in toward the bed rail). (Fig. 6A)

Proper care and placement of the sweep seal will ensure smooth operation of the cover. Alcohol, petroleum based or silicon-based cleaners such as Armor-All® should be avoided and ARE NOT recommended for our covers

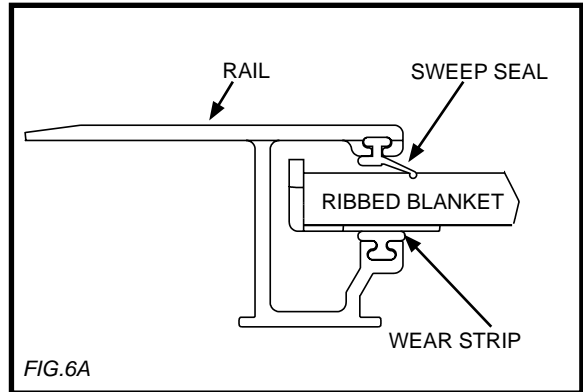

STEP 7: CONNECTING THE ELECTRONICS

HARDWARE USED:



2-BUTTON REMOTE
KEY FOB x 2

The electronics box has been pre-mounted to the inside of the canister.

Connect the battery wire harness into the 2-wire plug at the end of the canister (**also connect the optional manual switch harness, if installed at this time**)

Attach the Red (positive) and Black (negative) wires to the battery or the truck manufacturers suggested connection points at this time.

Unit is now ready to operate.

Press the Open button to open cover and press the Close button to shut the cover.

STEP 8: INSTALLING DRAIN TUBES

First ensure that the washer is in place on the drain tube end being inserted into the canister (This will prevent water leakage).

With the cover *opened*, insert the drain tube fittings into the pre-drilled holes on the underside of the canister by pushing them in place from under the canister. Drain tube should click into place.

Place the other end of the drain tube through the grommet or through the pre-drilled holes in the floor or the front wall of the truck bed.

DRAIN TUBE FITTING

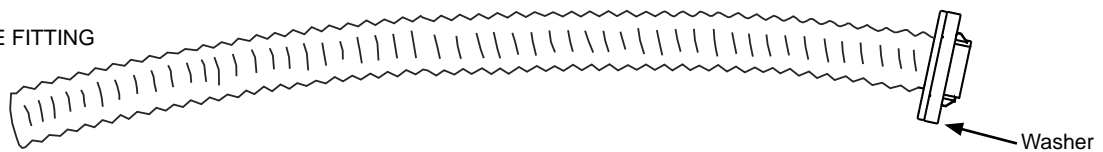

STEP 9: ATTACHING TOP COVER

HARDWARE USED:



BLACK TOP COVER
SCREW x 2

Place the top cover on the canister opening and install the (2) Black Top Cover Screws into the attachment blocks mounted to the inside of the canister.

Hold the top cover tight against the cab side of the box while tightening.

(The top cover can be adjusted slightly to align evenly with the ribbed blanket)

You have now completed the installation of your Bedlocker Electric hard tonneau cover. If you have any questions please do not hesitate to call us at: (800) 338-3697 and ask for our technical service department.

RELEASE HANDLE INSTRUCTIONS

If power is lost to the Bedlocker unit or the electric drive system fails to operate and you have to use the cover right away you can do the following to open or close the cover:

1. You will need to gain access to the release handle located on the driver side of the canister at the front of the truck bed. Once you have access to it, Pull the handle out away from the canister and pull out the handle kickstand behind it.
2. Settle the kickstand into the notch on the handle to hold the handle in place.
3. Now you should be able to push or pull the paneled blanket manually open or closed.

NOTE: The blanket will not lock unless you disengage the kickstand and lower the release handle. With the handle released the cover will move a short distance and the cover will then lock itself in place. (Cover may not lock tightly against tailgate)

This process will allow you to use the cover until power is restored. It is not meant for extended or permanent use.

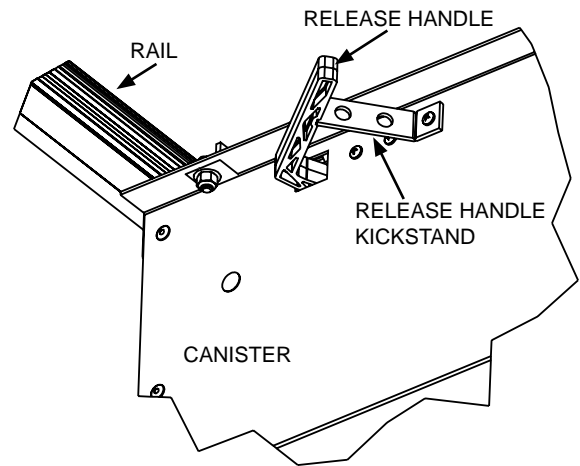

HELPFUL MAINTENANCE HINTS

After installation, if the cover is tight or hard to open and close, the shimming may need to be re-adjusted.

Periodically remove the Top Cover and clean out the canister.

Drain tubes may become clogged overtime and should be removed and cleaned. To remove the drain tubes you must; Remove the Top Cover, close the cover to the tailgate, reach in the canister and depress the plastic retaining tabs on the drain tube fittings and push the drain tube out of the hole in the bottom of the canister. (Fig. 1)

To help keep the Bedlocker retractable tonneau cover looking its best, we recommend washing it the same as caring for your truck finish. However due to the hammer texture, removal of wax can be difficult so you should not wax your cover.

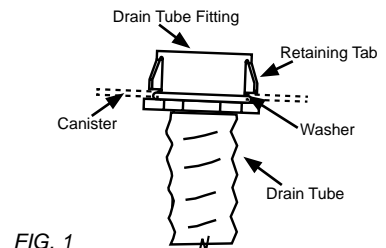

RELEASE HANDLE ASSEMBLY MAINTENANCE

Maintenance of the Release Handle Assembly requires lubrication of the coupler located inside the canister. This is done during factory assembly but may need to be done from time to time during the life of your cover.

A small lubrication hole is provided on the coupler that a fine tipped grease gun can inject a small amount of grease into. a high quality waterproof wheel bearing grease is recommended.

To get to the coupler you will need to remove the rail clamps and end caps at the end of the rails. Use the manual release handle and **manually** pull the blanket out the end of the rails until you have access to the coupler inside the canister. Grease the coupler, cycle and spin it to distribute lubricant then reverse the process to re-assemble the cover being sure to **manually** push the cover back into place in the canister. **(DO NOT USE THE MOTOR TO RUN THE BLANKET INTO THE CANISTER OR YOU WILL DAMAGE THE RIB CAPS ON THE EDGES OF THE BLANKET.)**

CONGRATULATIONS!

On your purchase of a Pace Edwards Retractable Truck Bed Cover. We are confident that you will get many years of trouble free service from this accessory to your truck. Please take a moment to fill out the warranty registration form to activate warranty coverage of your truck bed cover.

PACE EDWARDS PRODUCT WARRANTY

PACE EDWARDS (hereinafter referred to as the MFG.) warrants each new Pace Edwards Bedlocker®, JackRabbit®, Full-Metal-JackRabbit™, and Roll-Top-Cover® retractable truck bed cover to the original owner as follows:

FOR A PERIOD OF THREE (3) YEARS FROM THE DATE THE UNIT IS DELIVERED TO THE FIRST PURCHASER OR PLACED INTO SERVICE AS A DEMONSTRATOR OR COMPANY UNIT:

- Delamination of the ArmorTek deck
- Separation of the Bedlocker/Full Metal deck panels
- Failure of the Continuous Tension Spring
- Failure of the Bedlocker drive system
- All lock assemblies
- All hardware and components

ITEMS NOT COVERED UNDER WARRANTY FOR ANY PERIOD OF TIME:

- Rips, tears, or discoloration of the ArmorTek deck material
- Seals and gaskets
- Water intrusion from any source
- Dealer and/or purchaser installed parts and accessories

CERTAIN CONDITIONS WILL VOID ALL WARRANTY.

These conditions include:

- Use for any purpose other than normal private use including rental and promotion
- Altering the retractable truck bed cover in any manner without written approval of the MFG
- Misuse, negligence or accident
- Installation of any part or accessory without written approval from the MFG
- Failure to register this warranty with the MFG within fourteen (14) days from date of delivery

CLAIM PROCEDURE

If a part fails, the purchaser should return to the selling dealer to determine if the failed part is covered under the terms of this warranty. If a Warranty Claim is necessary, the dealer will contact Pace Edwards to obtain A Return Goods Authorization. If it is impractical for the purchaser to return to the selling dealer, then the purchaser may contact the Pace Edwards Technical Assistance Help Desk at 1-800-338-3697 to determine warranty eligibility. In either event, it is the responsibility of the purchaser to obtain a Return Goods Authorization prior to returning the defective part to the MFG. The defective part, along with a copy of the original Bill of Sale and the Pace Edwards issued RGA #, must be returned PREPAID to Pace Edwards Co. 2400 Commercial Blvd. Centralia, WA 98531. After determining the validity of the warranty claim, PACE EDWARDS will ship a replacement part prepaid to the customer. Labor costs to replace defective parts are the responsibility of the purchaser.

CONDITIONS AND LIMITATIONS

This warranty is subject to certain conditions and limitations including, but not limited to, the following:

- Any part of a Pace Edwards retractable truck bed cover that is found to be defective under the terms of this warranty will be repaired or replaced using either new or reconditioned parts at the discretion of the MFG.
- In determining what constitutes a failure under the terms of this warranty the decision of the MFG shall be final.
- This warranty is extended to the original purchaser only and is not transferable to subsequent purchasers.
- The MFG does not accept any responsibility in connection with the installation of any of its products by its dealers or agents.
- The MFG does not undertake responsibility to any purchaser for warranty express or implied by any of its dealers, distributors or agents beyond that which is contained herein.
- Without regard to an alleged defect of its products the MFG under any circumstances does not assume responsibility for loss of time, inconvenience, revenue, or other consequential damage including, but not limited to, expenses for telephone, food, lodging, travel, loss or damage to the vehicle the products are installed on or loss or damage to personal property of the purchaser or user of the products.
- The MFG reserves the right to make changes in the design of, improvements to, or warranty of its products without imposing any obligation upon itself to provide the same for any products theretofore manufactured.

Some jurisdictions do not allow limitations on or exclusions to warranties, therefore some of the exclusions may not apply to you. This warranty affords you specific legal rights. You may have other legal rights that may vary from jurisdiction to jurisdiction.

WARRANTY REGISTRATION

Please return this completed warranty registration within 14-days to:

Or go online and register your warranty at:

www.paceedwards.com/warranty-care

Pace Edwards
Attn: Warranty Dept.
2400 Commercial Blvd.
Centralia, WA 98531



NAME: _____

ADDRESS: _____

CITY: _____ PROV./STATE: _____ PC/ZIP: _____

MODEL #: _____ SERIAL #: _____

DATE OF PURCHASE: _____ PURCHASED FROM: _____ PRICE PAID: _____

CUSTOMER SIGNATURE: _____

2400 Commercial Blvd, Centralia, WA 98531 USA
(360) 736-9991 (main) ♦ (360) 736-9992 (fax)
(800) 338-3697 (toll-free)
www.paceedwards.com

Thank you for choosing products by...



#1 RETRACTABLE TRUCK BED COVER