

PACE EDWARDS RETRACTABLE UTILITY BED COVER

INSTALLATION INSTRUCTIONS



Pace Edwards Company
2400 Commercial Blvd.
Centralia WA 98531

(800) 338-3697 toll free
(360) 736-9991 main
(360) 237-7839 fax

www.paceedwards.com

TABLE OF CONTENTS

Required Tools.....	2
Before You Start	2
Packaging Contents	2
Hardware Kit.....	3
1. Place the Canister	4
2. Installing the Horizontal Rails	4
3. Installing the drain tubes	5
4. Install & Match Drill Horizontal rail clamps	5
5. Shim the Horizontal Rail Clamps.....	5
6. Bolt Down Horizontal Rail Clamps	6
7. Install Corner Blanket Guide	6
8. Install Vertical Rail Clamps.....	7
9. Install the Top Cover.....	8
10. Lubricate the Rail seals	8
11. Pull Cover Closed - Complete Installation	8
Helpful Maintenance Hints	9
Warranty Statement.....	10

TOOLS REQUIRED FOR ASSEMBLY:

Electric Drill
1/4" drill bit,
1/2" drill bit
9/32 Allen Wrench

7/16 Socket Wrench
Phillips screw Driver #1 & #2
Tape Measurer
Rubber mallet

BEFORE YOU START:

Read the instructions carefully before you start. If you have questions regarding the installation of your new Retractable Utility Bed Cover, please call our Technical Support Line at (800) 338-3697.

PACKAGING CONTENTS:

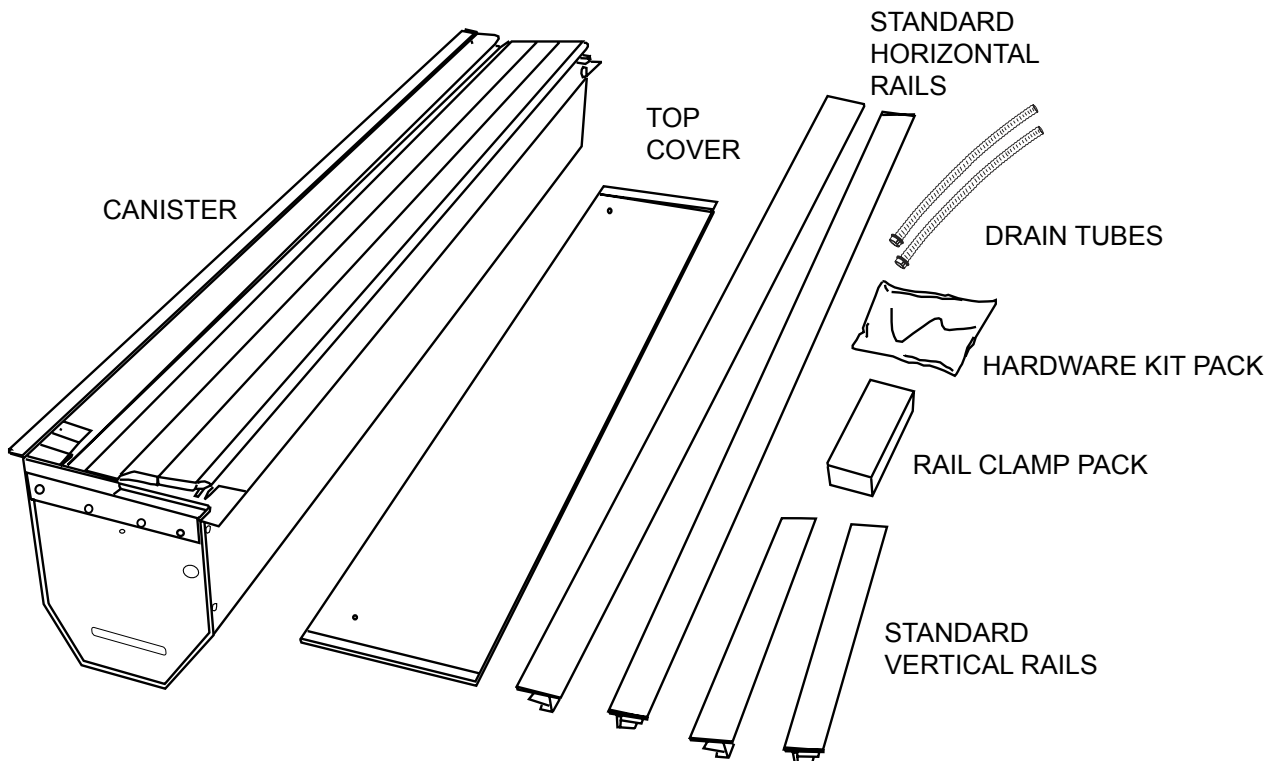

HARDWARE KIT:



1/4"-20 x 5/8"
BOLT x 2



1/4" LOCK WASHER
x 2



1/4" FLAT WASHER
x 2

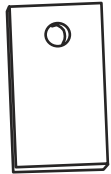

PLASTIC
SHIMS (x 20)

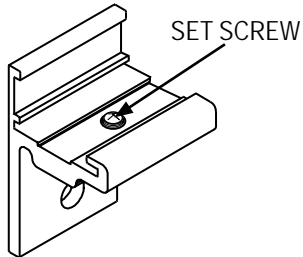

CLAMP (x 10)
w/ installed set
screws (x10)



1/4-20 x 1 1/4 CLAMP
BOLT (x 10)



1/4 FENDER
WASHER (x 10)



1/4 - 20
NYLOCK (x 10)

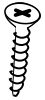

#10 x 3/4 BLACK
SHEET METAL
SCREW (x 4)

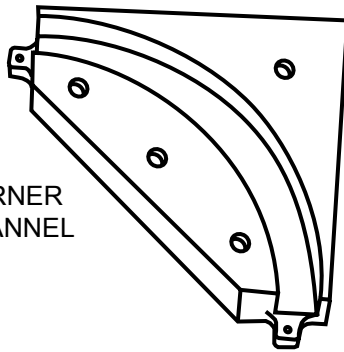

CORNER
CHANNEL
(x 2)



#6-32 x 3/8
STOP STRIP
CORNER
SCREW (x 2)



#10-32 x 7/8 BLACK
TOP COVER
SCREW (x 2)

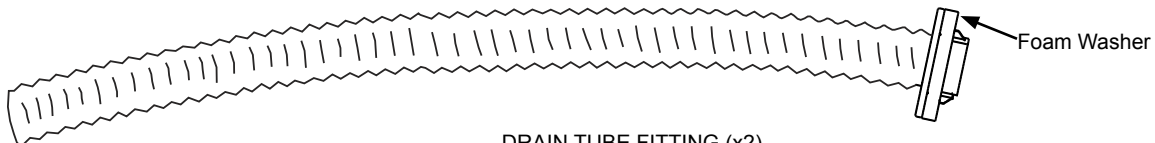

DRAIN TUBE FITTING (x2)

Foam Washer

1. PLACE THE CANISTER



Prior to placing canister in the bed you will want to protect the paint with a couple of towels or pieces of packing foam since the fit is very tight, there is a risk of scratching the sides of the bed. Blue painters tape works well for protection also.

This will require two people. Set the canister on a stand at the front end of the bed so that the sides of the canister are above the sides of the truck bed about 3 inches. (A folding chair works well). (Fig. 1A)

Pull approximately 4-5 ribs of the cover out of the canister.

2. INSTALLING THE HORIZONTAL RAILS SAME FOR BOTH STANDARD OR EXPLORER SERIES RAILS



The tailgate end of the rail can damage your box during installation; we recommend wrapping the ends of the rails or protecting the sides and top of box to prevent accidental damage.

MAKE SURE TO REMOVE THE WHITE LINER FROM THE FOAM ON THE BACKSIDE OF THE RAILS IT IS FOR PACKAGING PURPOSES ONLY. (Fig. 2A)

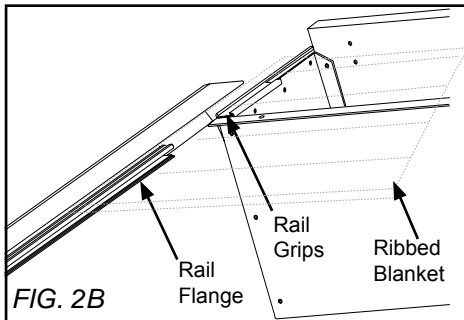

Starting with either rail you will need to hold the rail level and slide the lower rail (**male profile**) into the rail grip (**female profile**) that is bolted to each side of the canister (Fig. 2B). You must hold the ribbed blanket out and level while sliding the rail over it and into the rail grip on the canister. (Fig. 2C) Tilting the rail to get it inserted right then bringing it level works well. (Fig. 2D)

When properly inserted in the rail grips on the canister push the rails all the way forward.

Once the rails are in place on both sides of the canister you can remove the protection you placed on the bed and remove the stand the canister was set on. Lowering the canister with rails attached onto the truck box. The canister will fit tight and need to be centered in the truck bed.

Secure the canister to the rails with the $\frac{1}{4}$ -20 x $\frac{5}{8}$ CANISTER BOLT, $\frac{1}{4}$ washer, and $\frac{1}{4}$ lock washer (Figure 2E)



3. INSTALLING THE DRAIN TUBES

First ensure that the “o” ring is in place on the drain tube end being inserted into the canister. (This will prevent water leakage)

With the cover opened, insert the drain tube fittings into the pre-drilled holes on the underside of the canister by pushing them in place from under the canister.



The drain tube should click into place.

Route the end of the drain tubes out any existing drain holes present in the bed.

If no drain holes are provided you will have to drill 2 - 3/4” holes that you can push the drain hose through. **(Make sure to touch up any holes drilled to prevent corrosion).**

4. INSTALL AND MATCH DRILL THE HORIZONTAL RAIL CLAMPS

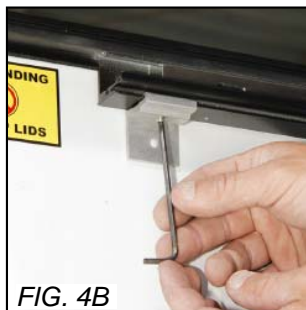

Make sure the canister is centered in the truck bed at this point and throughout this step.

(Flexing the rails inward prevents the clamps from scratching the paint).

Install the rail clamps by flexing the rails inward slightly, then slide one rail clamp all the way forward against the canister on both rails about 4”-6” from the canister. (Figure 4A) Tighten the set screw (Figure 4B) Do the same for the Middle clamp (place midway between the two other clamps) and the End clamp (Place about an inch from the corner channel) on both side rails (left and right).

Apply downward pressure to the rail and match drill the truck body with the hole in the the clamp. (Figure 4C)

5. SHIM THE HORIZONTAL RAIL CLAMPS (IF NEEDED)



Measure between the rails to determine the need for shims. (Figure 5A)

The gap between the backside of the rail clamp and the side of the truck bed will need to be shimmed. Remove the paper backing to expose the sticky side of the shim. (Figure 5B)

To shim, move the rail clamp and place as many of the plastic shims between the rail and the bed sidewall as needed to fill the gap. (Figure 5C) Place the same number of shims on each side rail to maintain even centering.

6. BOLT DOWN HORIZONTAL RAIL CLAMPS

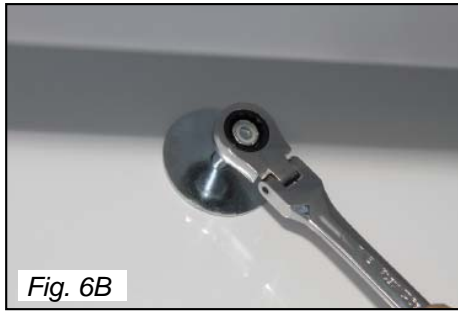

With the rails shimmed properly

Measure the width between the rails at the canister end and then at the tailgate end. This width must not be wider at the tailgate than the canister end. The width is best if shimmed $1/16^{\text{th}}$ to $1/8^{\text{th}}$ maximum narrower at the tailgate end.

With a partner on the outside of the truck to help, use the $1/4$ -20x $1\frac{1}{4}$ Clamp Bolt, Fender washer, and $1/4$ -20 nylock washer to secure all the clamps to the truck body. (Figure 6A & 6B)

7. INSTALLING CORNER BLANKET GUIDE

The Corner Channel must be shimmed, using the plastic shims provided, the same as the rails so that it is flush with the inside of the rails.

It is essential that the horizontal and vertical rails are evenly spaced from side to side and square from front to rear by measuring and making sure all measurements are the same.

Attach the corner channel to the horizontal rail with the 2 - 10 x $3/4$ BLACK SHEET METAL SCREW. (Figure 7A)

Attache the corner blanket guide the the vertical rail with the 2- 10 x $3/4$ BLACK SHEET METAL SCREW. (Figure 7B)

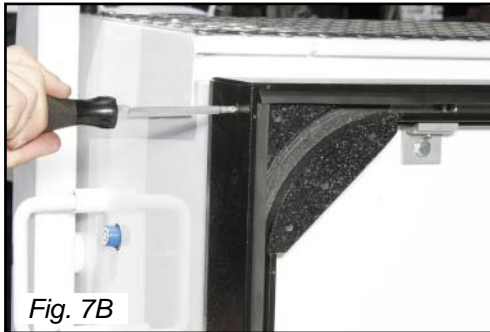

8. INSTALL VERTICAL RAIL CLAMPS

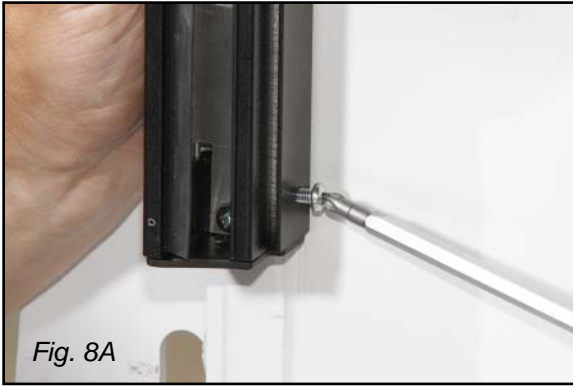

Temporarily remove the end cap screw. (Figure 8A)

Slide the clamps on the vertical rail and secure into place with the allen wrench and set screw. (Figures 8B & 8C)

Match Drill the Vertical Rail clamps to the truck body. (Figure 8D)

Add shims as needed then secure the vertical rail clamps with your partner on one side you on the other. (Figure 8E)

Secure the Vertical rail stop strip to the corner blanket guide. with the #6-32- $\frac{3}{8}$ STOP STRIP CORNER SCREW (Figure 8F)

Attach the pull strap to one side rail with the previously removed end cap screw. (Figure 8G)

Reinstall the other end cap screw in the other side.

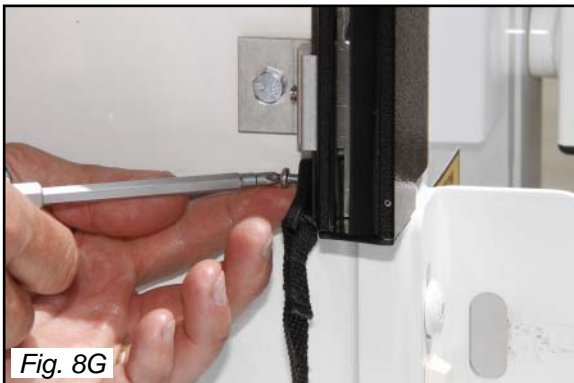
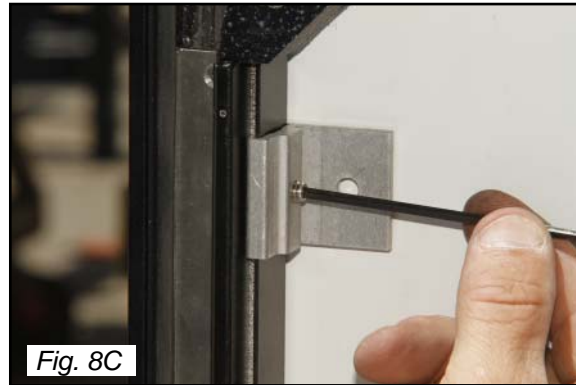
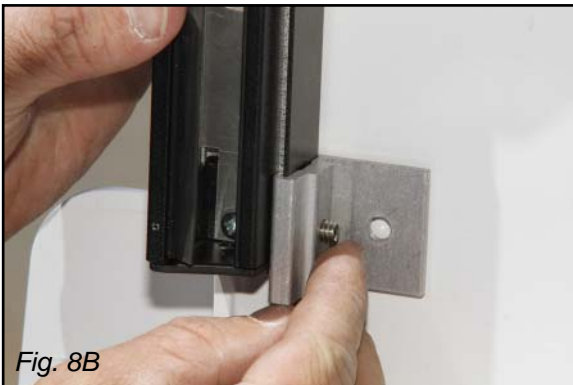

9. INSTALL THE TOP COVER

Install the top cover on the canister making sure it is flush with the horizontal rail. Use the 2-Black Top Cover Screws.



10. LUBRICATE THE RAILS

Use the included 303 protectant to lubricate the sweep seal and wear strip. This ensures the cover glides smoothly the first time it is very important to lubricate the seals on the rails. You will need to periodically lubricate these seals throughout the life of the cover. We recommend using the 303 Brand protectant.



11. COMPLETE INSTALLATION

Pull the cover closed and the installation is complete.



HELPFUL MAINTENANCE HINTS

To assure quiet, smooth operation, apply a small amount of grease to the guide strips where the metal end of the panels and the guide strips meet. This initial application should be sufficient for a year or more. Regrease the guide strips if the cover begins squeaking during use.

Drain tubes may become clogged over time and should be removed and cleaned.

Periodically remove the top cover and clean out the canister.

To help keep the tonneau cover looking its best, we recommend washing it the same as caring for your truck finish.

If you have any questions please call our Technical Support at (800) 338-3697.

INSTALLING THE OPTIONAL TAILGATE LOCK

THIS IS ONLY USED WHEN YOUR COVER GOES TO THE TOP OF THE TAILGATE AND YOUR TAILGATE IS NON-LOCKING. IT IS AN OPTION YOU MUST SPECIFY YOU WANT WHEN ORDERING.

Attach the (optional) tailgate lock angle piece to the cover. using the 10 x $\frac{3}{4}$ BLACK SHEET METAL SCREW (x 2) (Figure 12A) (If your truck has a lockable tailgate this may not be needed.)

Transfer the location of the angle to the tailgate. (Figures 12B & 12C) We put masking tape down so as to not mark directly on the tailgate.

Correctly position the tailgate lock block, match drill the holes into the tailgate and attach the tailgate block to the tailgate. Using the #8 x $1\frac{1}{4}$ SCREW (x 4) (Figures 12D & 12E)

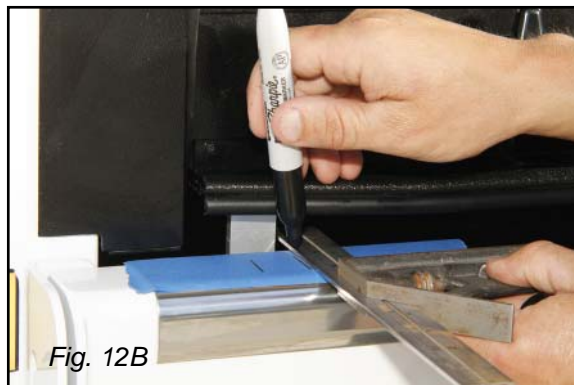

CONGRATULATIONS!

On your purchase of a Pace Edwards Retractable Truck Bed Cover.

We are confident that you will get many years of trouble free service from this accessory to your truck. Please take a moment to fill out the warranty registration form to activate warranty coverage of your truck bed cover.

PACE EDWARDS PRODUCT WARRANTY

PACE EDWARDS (hereinafter referred to as the MFG.) warrants each new Pace Edwards Bedlocker®, JackRabbit®, Full-Metal-JackRabbit™, and Roll-Top-Cover® retractable truck bed cover to the original owner as follows:

FOR A PERIOD OF THREE (3) YEARS FROM THE DATE THE UNIT IS DELIVERED TO THE FIRST PURCHASER OR PLACED INTO SERVICE AS A DEMONSTRATOR OR COMPANY UNIT:

- Delamination of the ArmorTek deck
- Separation of the Bedlocker/Full Metal deck panels
- Failure of the Continuous Tension Spring
- Failure of the Bedlocker drive system
- All lock assemblies
- All hardware and components

ITEMS NOT COVERED UNDER WARRANTY FOR ANY PERIOD OF TIME:

- Rips, tears, or discoloration of the ArmorTek deck material
- Seals and gaskets
- Water intrusion from any source
- Dealer and/or purchaser installed parts and accessories

CERTAIN CONDITIONS WILL VOID ALL WARRANTY.

These conditions include:

- Use for any purpose other than normal private use including rental and promotion
- Altering the retractable truck bed cover in any manner without written approval of the MFG
- Misuse, negligence or accident
- Installation of any part or accessory without written approval from the MFG
- Failure to register this warranty with the MFG within fourteen (14) days from date of delivery

CLAIM PROCEDURE

If a part fails, the purchaser should return to the selling dealer to determine if the failed part is covered under the terms of this warranty. If a Warranty Claim is necessary, the dealer will contact Pace Edwards to obtain A Return Goods Authorization. If it is impractical for the purchaser to return to the selling dealer, then the purchaser may contact the Pace Edwards Technical Assistance Help Desk at 1-800-338-3697 to determine warranty eligibility. In either event, it is the responsibility of the purchaser to obtain a Return Goods Authorization prior to returning the defective part to the MFG. The defective part, along with a copy of the original Bill of Sale and the Pace Edwards issued RGA #, must be returned PREPAID to Pace Edwards Co. 2400 Commercial Blvd. Centralia, WA 98531. After determining the validity of the warranty claim, PACE EDWARDS will ship a replacement part prepaid to the customer. Labor costs to replace defective parts are the responsibility of the purchaser.

CONDITIONS AND LIMITATIONS

This warranty is subject to certain conditions and limitations including, but not limited to, the following:

- Any part of a Pace Edwards retractable truck bed cover that is found to be defective under the terms of this warranty will be repaired or replaced using either new or reconditioned parts at the discretion of the MFG.
- In determining what constitutes a failure under the terms of this warranty the decision of the MFG shall be final.
- This warranty is extended to the original purchaser only and is not transferable to subsequent purchasers.
- The MFG does not accept any responsibility in connection with the installation of any of its products by its dealers or agents.
- The MFG does not undertake responsibility to any purchaser for warranty express or implied by any of its dealers, distributors or agents beyond that which is contained herein.
- Without regard to an alleged defect of its products the MFG under any circumstances does not assume responsibility for loss of time, inconvenience, revenue, or other consequential damage including, but not limited to, expenses for telephone, food, lodging, travel, loss or damage to the vehicle the products are installed on or loss or damage to personal property of the purchaser or user of the products.
- The MFG reserves the right to make changes in the design of, improvements to, or warranty of its products without imposing any obligation upon itself to provide the same for any products theretofore manufactured.

Some jurisdictions do not allow limitations on or exclusions to warranties, therefore some of the exclusions may not apply to you. This warranty affords you specific legal rights. You may have other legal rights that may vary from jurisdiction to jurisdiction.

WARRANTY REGISTRATION

Please return this completed warranty registration within 14-days to:

Pace Edwards

Or go online and register your warranty at:

<http://www.pace-edwards.com/Warranty-Care>



NAME: _____

ADDRESS: _____

CITY: _____ PROV./STATE: _____ PC/ZIP: _____

MODEL #: _____ SERIAL #: _____

DATE OF PURCHASE: _____ PURCHASED FROM: _____ PRICE PAID: _____

CUSTOMER SIGNATURE: _____



**Pace Edwards Company
2400 Commercial Blvd.
Centralia WA 98531**

**(800) 338-3697 toll free
(360) 736-9991 main
(360) 237-7839 fax**

www.paceedwards.com